

DA-685 Series Hardware Manual

Second Edition, August 2012

www.moxa.com/product



© 2012 Moxa Inc. All rights reserved.

Reproduction without permission is prohibited.

DA-685 Series Hardware Manual

The software described in this manual is furnished under a license agreement and may be used only in accordance with the terms of that agreement.

Copyright Notice

Copyright ©2012 Moxa Inc.
All rights reserved.
Reproduction without permission is prohibited.

Trademarks

The MOXA logo is a registered trademark of Moxa Inc.
All other trademarks or registered marks in this manual belong to their respective manufacturers.

Disclaimer

Information in this document is subject to change without notice and does not represent a commitment on the part of Moxa.

Moxa provides this document as is, without warranty of any kind, either expressed or implied, including, but not limited to, its particular purpose. Moxa reserves the right to make improvements and/or changes to this manual, or to the products and/or the programs described in this manual, at any time.

Information provided in this manual is intended to be accurate and reliable. However, Moxa assumes no responsibility for its use, or for any infringements on the rights of third parties that may result from its use.

This product might include unintentional technical or typographical errors. Changes are periodically made to the information herein to correct such errors, and these changes are incorporated into new editions of the publication.

Technical Support Contact Information

www.moxa.com/support

Moxa Americas

Toll-free: 1-888-669-2872
Tel: +1-714-528-6777
Fax: +1-714-528-6778

Moxa Europe

Tel: +49-89-3 70 03 99-0
Fax: +49-89-3 70 03 99-99

Moxa China (Shanghai office)

Toll-free: 800-820-5036
Tel: +86-21-5258-9955
Fax: +86-21-5258-5505

Moxa Asia-Pacific

Tel: +886-2-8919-1230
Fax: +886-2-8919-1231

Table of Contents

1. Introduction	1-1
Overview	1-2
Model Descriptions and Package Checklist.....	1-2
Appearance.....	1-2
Features	1-3
Hardware Block Diagram	1-4
Hardware Specifications	1-4
2. Hardware Installation	2-1
Placement Options	2-2
Desktop	2-2
Rack mounting.....	2-2
Wiring Requirements.....	2-4
Connecting the Power Supply	2-5
Wiring the Power Inputs	2-6
Power Input Wiring Description	2-7
HIPOT (Dielectric Strength) Testing	2-7
Front Panel LED.....	2-8
Connecting to a Display	2-9
Connecting a PS/2 Keyboard and Mouse.....	2-9
Connecting USB Devices	2-10
Connecting Serial Devices.....	2-10
LAN Ports	2-11
Upgrading the Memory Module	2-12
Installing a CompactFlash Card	2-13
Installing a SATA Storage Drive.....	2-14
Upgrading a DOM	2-15
3. BIOS Setup	3-1
Entering the BIOS Setup Utility	3-2
BIOS Main Page.....	3-2
Modifying BIOS Settings	3-3
Advanced Settings.....	3-3
Security Settings.....	3-8
Power Settings.....	3-9
Boot Settings.....	3-10
Exit Settings	3-12
Upgrading the BIOS	3-13
A. Safety Installation Instructions	A-1
B. Regulatory Statement Approval	B-1

Introduction

Thank you for purchasing the Moxa DA-685 series x86 industrial ready-to-run substation computer.

This manual introduces the hardware installation, connector interfaces, and BIOS setup of the DA-685. For software configuration and management, please refer to the user's manual for your operating system.

The following topics are covered in this chapter:

- ❑ **Overview**
- ❑ **Model Descriptions and Package Checklist**
- ❑ **Appearance**
- ❑ **Features**
- ❑ **Hardware Block Diagram**
- ❑ **Hardware Specifications**

Overview

DA-685 industrial computers excel in a wide array of substation automation roles. The DA-685 Series is an x86 platform and features VGA, 6 Gigabit Ethernet ports, 2 selectable RS-232/422/485 ports, 6 RS-485 serial ports, CompactFlash, and 2 USB 2.0 interfaces. The computers come in a 19-inch/2U chassis with an Intel Atom processor, giving them the punch needed to handle demanding industrial tasks but at an economical price and without consuming a lot of power.

The DA-685 Series comes with either Linux or Windows XP Embedded operating systems pre-installed, providing friendly environments for developing sophisticated applications no matter what your platform preferences. Moxa provides thorough product support to make the programmer's job easier, which helps programmers develop bug-free code quickly and economically.

Taken together, these features make DA-685 computers an excellent option for automating a wide array of electrical substation applications.

Model Descriptions and Package Checklist

The DA-685 Series includes the following models:

- DA-685-XPE: Rackmount x86 Computer with 1.66GHz CPU, VGA, 6 Gigabit Ethernet ports, 2 Software-selectable RS-232/422/485 ports, 6 Two Wire RS-485 interfaces, CompactFlash socket, 2 USB 2.0 ports, single power input, and Windows Embedded Standard
- DA-685-LX: Rackmount x86 Computer with 1.66GHz CPU, VGA, 6 Gigabit Ethernet ports, 2 Software-selectable RS-232/422/485 ports, 6 Two Wire RS-485 interfaces, CompactFlash socket, 2 USB 2.0 ports, single power input, and a Linux Operating System

Each model is shipped with following standard items:

- DA-685 electrical substation computer
- Rackmount assembly
- Documentation CD or DVD
- Quick installation guide (printed)
- Warranty card

Appearance

Front View

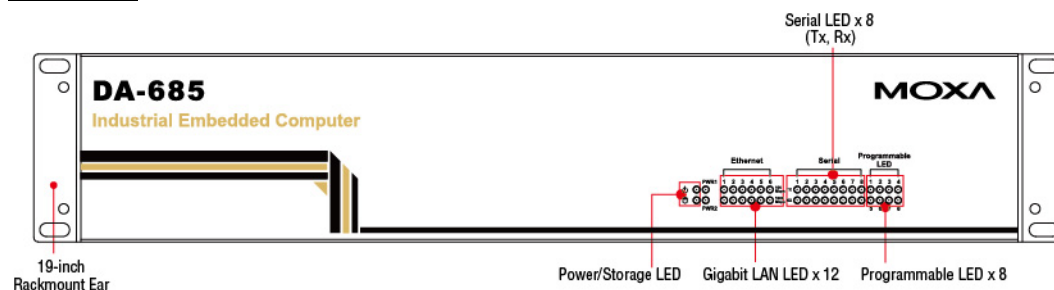

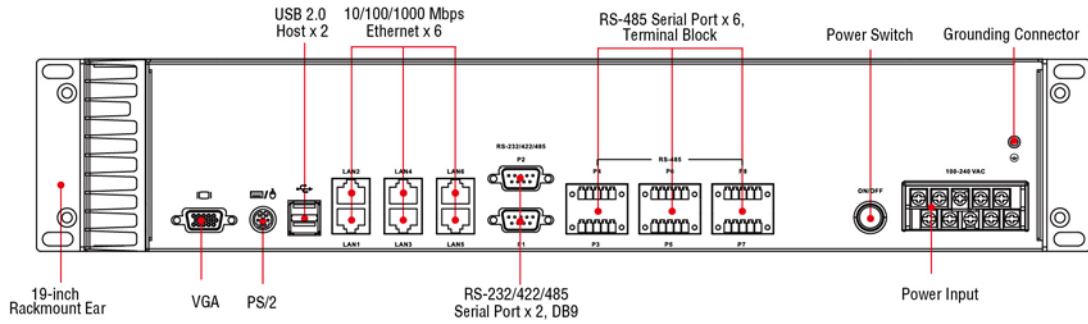
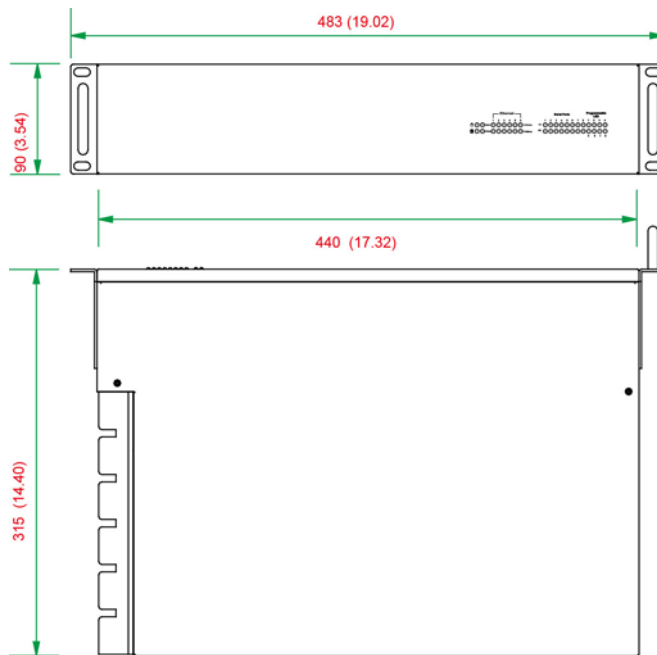
Rear View**Dimensions****Features**

The DA-685 computer has the following features:

- Intel Atom D510 1.66 GHz processor
- 1 DDR2 SODIMM sockets supporting DDR2 667 up to 2 GB (max.)
- 6 10/100/1000 Mbps Ethernet ports
- 2 selectable RS-232/422/485 DB9 (male) ports
- 6 two-wire RS-485 serial ports (terminal block)
- 2 USB 2.0 ports for high speed peripherals
- CompactFlash socket for storage expansion
- 1 SATA connector for storage media (HDD/SDD) expansion
- EMC Level 4 certified

**ATTENTION**

Refer to the “Non-standard Baudrates” section for instructions on how to calculate which baudrates are supported.

Hardware Block Diagram

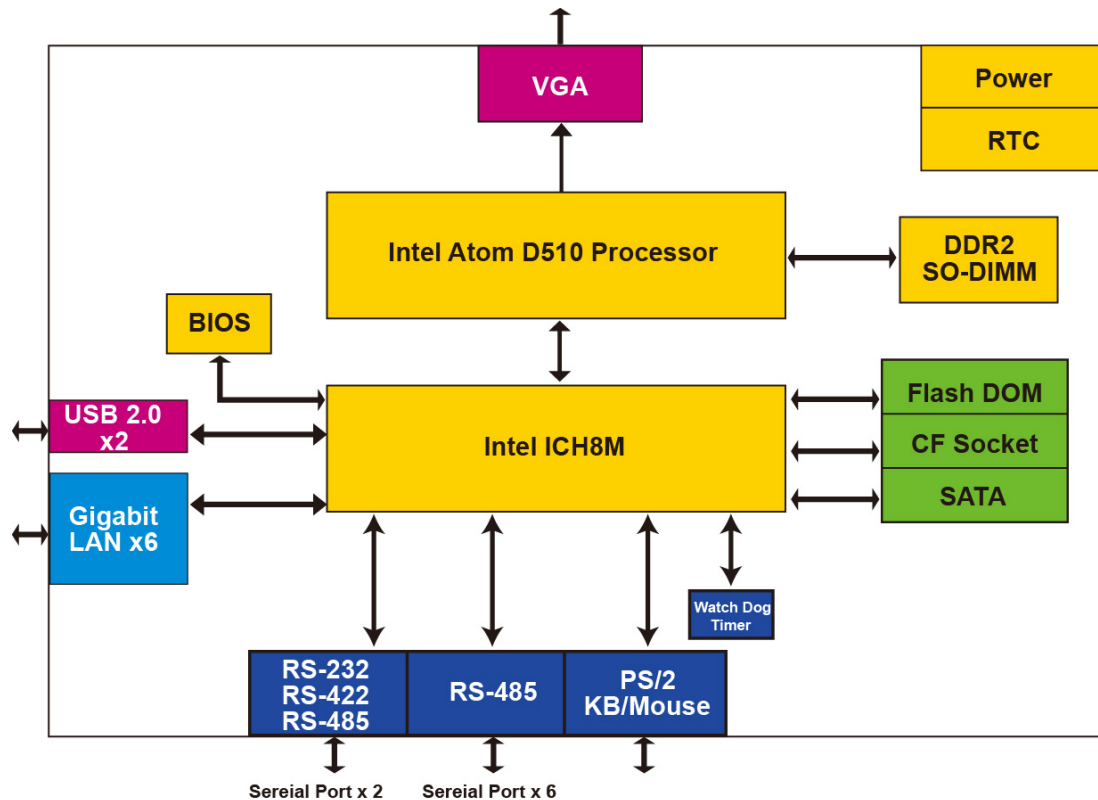

Hardware Specifications

Computer

CPU: Intel Atom D510 1.66 GHz processor

OS: Linux, Windows 7, Windows XP Professional, or Windows Embedded Standard 2009 (must be installed by the user)

System Chipset: Intel Pineview-D + ICH8M

BIOS: 16 Mbit Flash BIOS, PCI Plug & Play, ACPI function support

FSB: 667 MHz

System Memory: 1 200-pin DDR2 SODIMM socket supporting DDR2 667; up to 2 GB, with 1 GB built in

USB: USB 2.0 compliant ports, Type A connector x 2, supports system boot up

Storage

Built-in: 2 GB industrial DOM onboard to store OS

Storage Expansion: CompactFlash socket for CF card expansion, supporting CF Type-I/II

HDD Support: 1 SATA connector for HDD expansion

Other Peripherals

KB/MS: 1 PS/2 interface, supports standard PS/2 keyboard and mouse through Y-type cable

Display

Graphics Controller: Intel® GMA3150 graphics controller on Intel D510 card

Display Interface: VGA output (DB15 female connector)

Resolution: CRT display mode with pixel resolution up to 2048 x 1536 at 75 Hz

Ethernet Interface

LAN: 6 auto-sensing 10/100/1000 Mbps Gigabit ports

Magnetic Isolation Protection: 1.5 KV built-in

Serial Interface**Serial Standards:**

- 2 selectable RS-232/422/485 ports (DB9 male)
- 6 2-wire RS-485 ports (terminal block)

Serial Signals

RS-232: TxD, RxD, DTR, DSR, RTS, CTS, DCD, GND, RI

RS-422: TxD+, TxD-, RxD+, RxD-, GND

4-wire RS-485: TxD+, TxD-, RxD+, RxD-, GND

2-wire RS-485: Data+, Data-, GND

LEDs

System: Power, Storage

Gigabit LAN (GbE): 100M x 6, 1000M x 6

Serial: TX/RX

Programmable: LED x 8

Switches and Buttons

Power Switch: on/off (on rear panel)

Physical Characteristics

Housing: SECC sheet metal (1 mm)

Weight: 4 kg

Dimensions: 315 x 440 x 90 mm (12.40 x 17.32 x 3.54 in) (without rackmount ears)

Mounting: Standard 19-inch rackmount

Environmental Limits

Operating Temperature: -10 to 55°C (14 to 131°F)

Storage Temperature: -20 to 80°C (-4 to 176°F)

Ambient Relative Humidity: 5 to 95% (non-condensing)

Anti-vibration: 2 g rms @ IEC-68-2-34, random wave, 5-500 Hz, 1 hr per axis

Anti-shock: 20 g @ IEC-68-2-27, half sine wave, 11 ms

Power Requirements

Input Voltage: 100 to 240 VAC, 47/63 Hz, 0.6-0.3 A

Power Consumption: 40 W

Standards and Certifications

Safety: LVD, UL, cUL, CCC

EMC: FCC, CE (Class A)

Reliability

Alert Tools: Built-in buzzer and RTC (real-time clock) with lithium backup battery

Automatic Reboot Trigger: Built-in WDT (watchdog timer) supporting 1-255 level time interval system reset, software programmable

Warranty

Warranty Period: 3 years

Details: See www.moxa.com/warranty

Hardware Installation

The DA-685 Series of electrical substation computers are compact and rugged, making them suitable for any industrial application that requires EMC Level 4 compliance. The LED indicators allow users to monitor performance and identify trouble spots quickly, and multiple ports are provided for connecting a variety of different devices. The DA-685 hardware platform is stable, reliable, and easy to maintain, allowing you to spend your time on application development rather than troubleshooting networking bugs. This chapter describes the hardware installation and interfaces of DA-685 substation computers.

The following topics are covered in this chapter:

- ❑ **Placement Options**
 - Desktop
 - Rack mounting
- ❑ **Wiring Requirements**
- ❑ **Connecting the Power Supply**
- ❑ **Wiring the Power Inputs**
- ❑ **Power Input Wiring Description**
- ❑ **HIPOT (Dielectric Strength) Testing**
- ❑ **Front Panel LED**
- ❑ **Connecting to a Display**
- ❑ **Connecting a PS/2 Keyboard and Mouse**
- ❑ **Connecting USB Devices**
- ❑ **Connecting Serial Devices**
- ❑ **LAN Ports**
- ❑ **Upgrading the Memory Module**
- ❑ **Installing a CompactFlash Card**
- ❑ **Installing a SATA Storage Drive**
- ❑ **Upgrading a DOM**

Placement Options

Desktop

Place your DA-685 on a clean, flat, well-ventilated desktop. For better ventilation, leave some space between the DA-685 and other equipment. Do not place equipment or objects on top of the DA-685, as this might damage the computer's internal components.

Rack mounting

The DA-685 has rackmount supports for installing the embedded computer into a standard 19" rack.



ATTENTIONS

For maximum safety, at least two persons should work together to lift, place, and fasten the computer to the rack.

Before you lift or move the computer, first verify both it and any power to the rack system is turned off.

After installing the rackmount assembly (ears, handles), four screws are required to fasten the DA-685 to a rack.

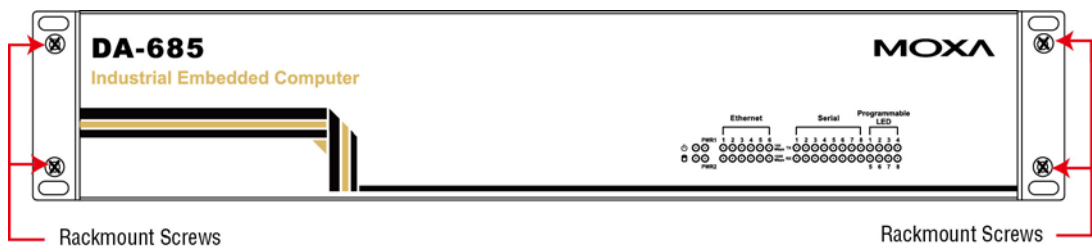

Follow these steps to mount the DA-685 on a rack:

Step 1: Installing the rack supports (ears)

The rackmount assembly should be included with your DA-685. If you do not find the assembly package please contact a Moxa representative for rectification. Each assembly should contain 2 rack ears and 12 FMSM4X6 screws. Please note that the handle and the FMSM5X10 screws are not included in the standard rackmount assembly; these are optional accessories that come separately. If you are interested, please contact Moxa for ordering information.



Step 2: Installing a rackmount handle (optional) to a rack ear

Use 2 FMSM5X10 screws to attach the rackmount handle to the ear, as shown.

**Step 3: Installing the rack ears to the DA-685**

For each side panel of the DA-685, use 6 FMSM4X6 screws to affix the ear to the DA-685, as shown below.

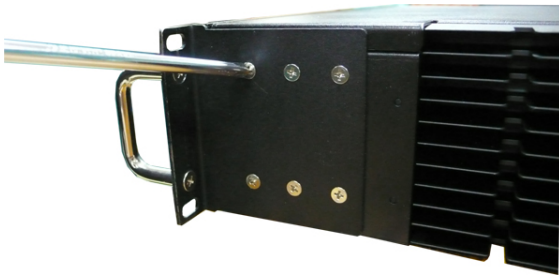
**Step 4: Installing the DA-685 to a rack**

Gently slide the DA-685 onto the rack and use the mounting screws provided by the rack supplier to affix the DA-685 in place.



NOTE Four screws are required to attach the DA-685 to the rack. Use two screws on the left side and two screws on the right side.

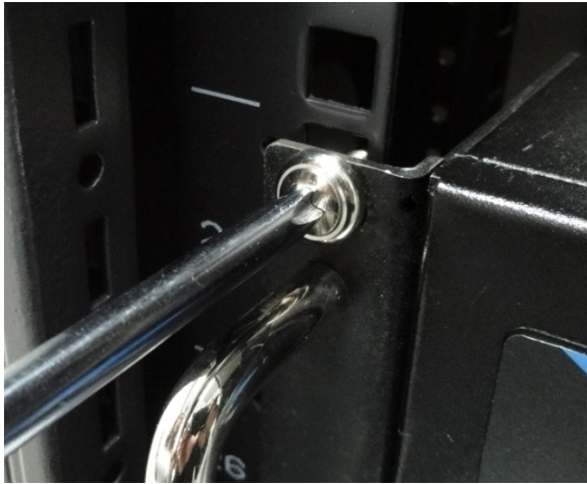

As a final check, make sure that the computer is snugly affixed in place.

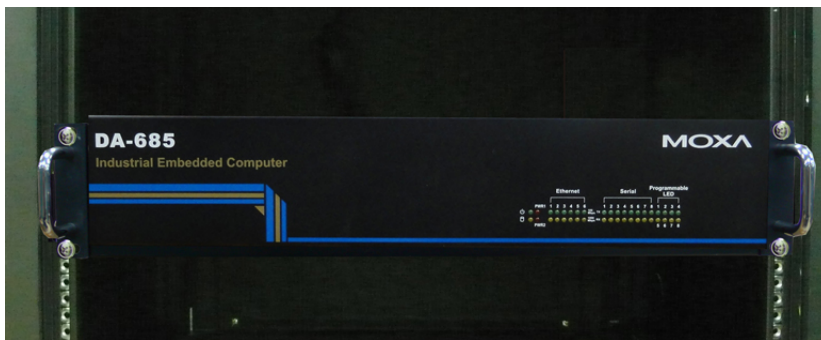

Wiring Requirements

The following common safety precautions should be observed before installing any electronic device:

- Strive to use separate, non-intersecting paths to route power and networking wires. If power wiring and device wiring paths must cross, make sure the wires are perpendicular at the intersection point.
- Keep the wires separated according to interface. The rule of thumb is that wiring that shares similar electrical characteristics may be bundled together.
- Do not bundle input wiring with output wiring separate.
- When necessary, it is strongly advised that you label wiring to all devices in the system.



ATTENTION

Do not run signal or communication wiring and power wiring in the same conduit. To avoid interference, wires with different signal characteristics (i.e., different interfaces) should be routed separately.



ATTENTION

Safety First!

Be sure to disconnect the power cord before installing and/or wiring your device.

Caution! High Electrical Current!

Calculate the maximum possible current for each power wire and common wire. Observe all electrical codes dictating the maximum current allowable for each wire size.

If the current goes above the maximum ratings, the wiring could overheat, causing serious damage to your equipment.

Caution! High Temperatures!

Be careful when handling the unit. When the unit is plugged in, the internal components generate a lot of heat which may leave the outer casing too hot to touch.

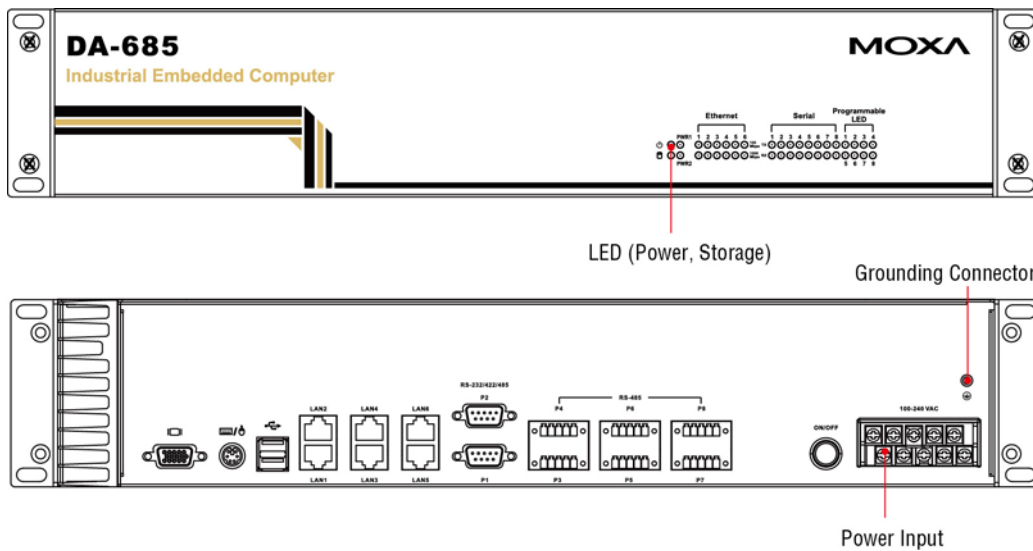

Connecting the Power Supply

The DA-685 offers both single power and dual power inputs. Use a screwdriver to remove the screws. Connect the power cord to the screws and then attach the screws to the unit. For single models (SP), use Power 1 only; for dual power models (DPP-T), use both Power 1 and Power 2 for power input installation. Refer to the following figure for detailed information.



Wiring the Power Inputs

PWR 1

+/L		NC	NC	NC
-/N		NC	NC	NC

Surge Ground

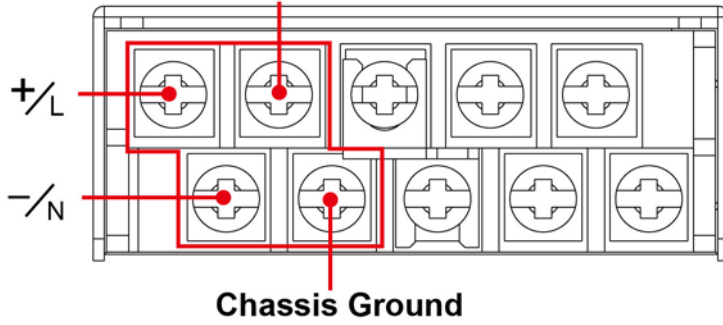

AC Terminal

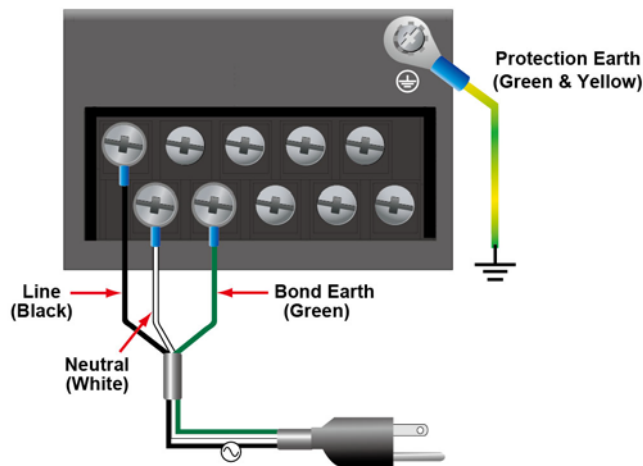

DC Terminal

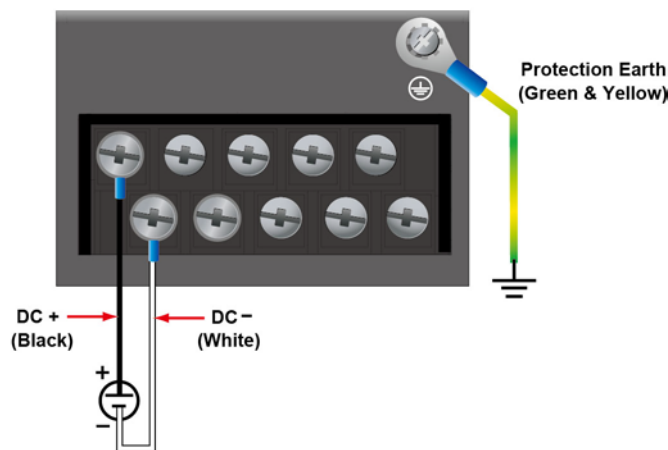

Power Input Wiring Description

Read the following section for a detailed power input wiring description.

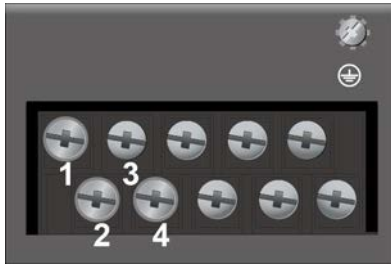

Terminal Number	Description	Note
1	PWR1 Line	PWR1 Line + is connected, or to the Line terminal for the AC power source.
2	PWR1 Neutral	PWR1 Neutral – is connected to the Neutral terminal for the AC power source.
3	PWR1 Surge Ground	PWR1 Surge Ground is connected to the Chassis Ground via a jumper on the terminal block. Surge Ground is used as the ground conductor for all surge and transient suppression circuitry. <i>NOTE: Surge Ground must be disconnected from Chassis Ground during HIPOT (dielectric strength) testing.</i>
4	Chassis Ground	Chassis Ground is connected to the Safety Ground terminal for AC inputs, chassis ground connects to both power supply surge grounds via a removable jumper.

For AC Power Input

1. PWR1 Line should be connected to AC (Line).
2. PWR1 Neutral should be connected to AC (Neutral).
3. Surge Ground is connected to the Chassis Ground via a braided cable or other appropriate grounding wire. Surge Ground is used as the ground conductor for all surge and transient suppression circuitry internal to the protection board.
4. Chassis Ground should be connected to the AC Ground terminal.



ATTENTION

1. Equipment must be installed according to the applicable country wiring codes.
2. Surge Ground **MUST** be disconnected from the Chassis Ground during HIPOT (dielectric strength) testing.
3. All line-to-ground transient energy is shunted to the Surge Ground terminal. In cases where users require the inputs to be isolated from the ground, remove the ground braid between Surge and Chassis Ground. Note that all line-to-ground transient protection circuitry will be disabled.

HIPOT (Dielectric Strength) Testing

Before performing the HIPOT test, you **MUST** have the jumpers removed and the braided ground cable disconnected. This is required to prevent the transient/surge suppression circuitry, which is connected to Surge Ground from being activated during the HIPOT test.

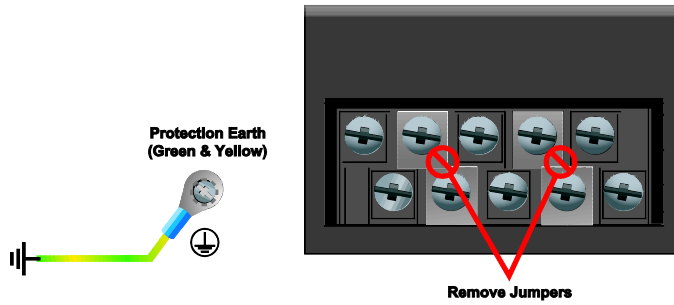

When finished, press the Power Switch button to start the system. It will take about 30 to 60 seconds for your operating system to boot up.

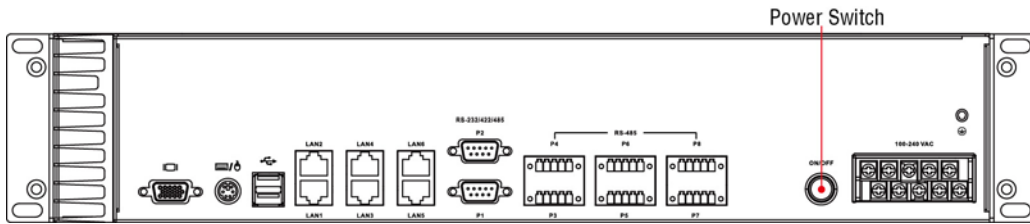

Front Panel LED

There are 40 LED indicators on the front panel. Information about each LED is given in the following table. The additional ports LEDs, named Port 1 and Port 2 are temporarily reserved for future use.

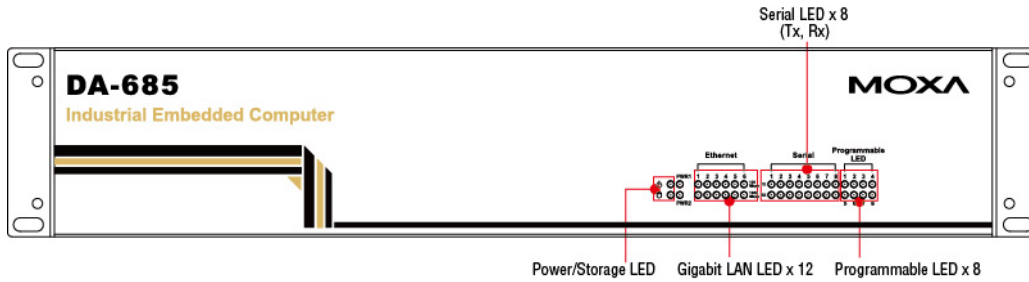

LED Name	Color	LED Description
Power	Green	Power is on
	Off	No power input or power error
Storage	Yellow / Blinking	Data is being written to or to read from the storage unit
	Off	Storage unit is idle
Ethernet Port 100 Mbps	Green	100 Mbps of Ethernet Port is active
	Off	No activity
Ethernet Port 1000 Mbps	Yellow	1000 Mbps of Ethernet Port is active
	Off	No activity
Serial Port TX 1-8	Green	Serial port is transmitting data
	Off	No operation
Serial Port RX 1-8	Yellow	Serial port is receiving data
	Off	No operation
Programmable Port 1-8	Green	Defined by users
	Yellow	Defined by users
Power Fail 1	Unused	--
	Unused	--
Power Fail 2	Unused	--
	Unused	--

Connecting to a Display

The DA-685 comes with a D-Sub 15-pin female connector on the front panel to connect a VGA monitor. To ensure that the monitor image remains clear, be sure to tighten the monitor cable after connecting it to the DA-685 computer. The pin assignments of the VGA connector are shown below.

DB15 Female Connector

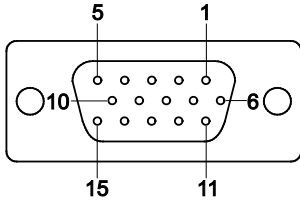

Pin No.	Signal Definition	Pin No.	Signal Definition
1	Red	9	VCC
2	Green	10	GND
3	Blue	11	NC
4	NC	12	DDC2B Data
5	GND	13	HSYNC
6	GND	14	VSYNC
7	GND	15	DDC2B Clock
8	GND		

Connecting a PS/2 Keyboard and Mouse

Your DA-685 embedded computer comes with a PS/2 mini-DIN connector to connect to a PS/2 keyboard and PS/2 mouse by using a Y-type cable. This 6-pin mini-DIN connector has the pin assignments shown below.

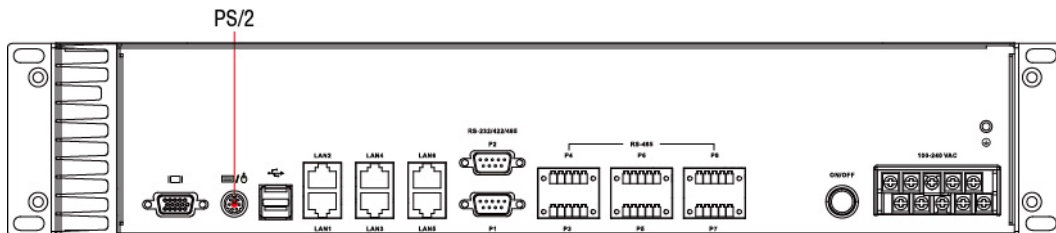

Pin No.	Signal Definition
1	PS/2 Keyboard Data
2	PS/2 Mouse Data
3	GND
4	VCC
5	PS/2 Keyboard Clock
6	PS/2 Mouse Clock

Use the Y-type cable to convert the mini-DIN connector into two 6-pin mini-DIN connectors to connect both a PS/2 keyboard and PS/2 mouse at the same time. (The Y-type cable is not included in the accessory package. It should be purchased separately. You may also use the USB ports to connect your USB-based keyboard and mouse.)





ATTENTION

Please note that without the Y-type cable, the PS/2 connector on the DA-685 can only work with a PS/2 keyboard. A PS/2 mouse will not function when directly connected to the PS/2 connector on the DA-685 embedded computer.

Connecting USB Devices

The DA-685 embedded computer has two USB 2.0 ports: two are on the front panel, and two are on the rear panel. All of the ports are UHCI, Rev 2.0 compliant and support Plug & Play and hot swapping. These ports can be used to connect USB devices, such as a keyboard, mouse, USB flash disk, and USB CD-ROM. In addition, both USB ports support system boot up, which can be activated by modifying the BIOS settings. The chapter “BIOS Setup” describes the configuration process in detail.

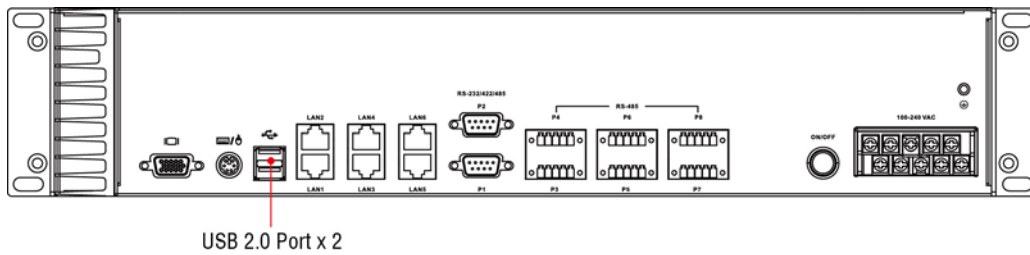

Connecting Serial Devices

The DA-685 comes with two RS-232/422/485 serial ports with DB9 male connectors, and six RS-485-2w serial ports with terminal blocks. See the following figure for the location of the serial ports on the rear panel.

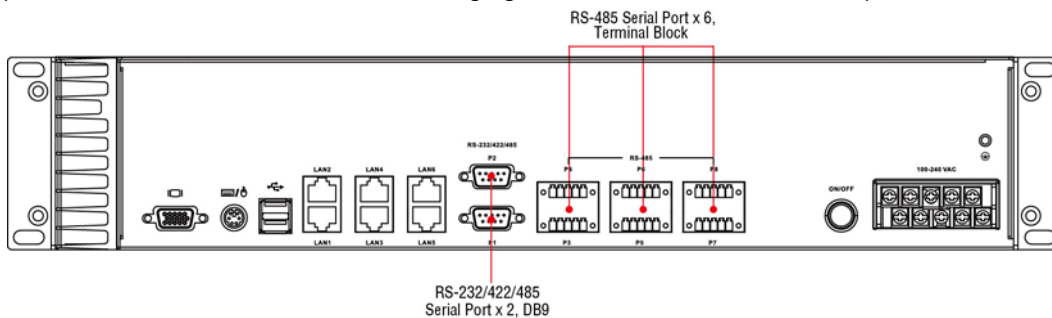

The pin assignments for RS-232/422/485 serial ports are shown in the following table:

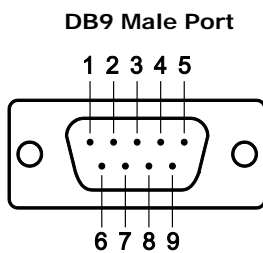

RS-232/422/485 Pinouts

Pin	RS-232	RS-422	RS-485-4W	RS-485-2W
1	DCD	TxDA(-)	TxDA(-)	—
2	RxD	TxDB(+)	TxDB(+)	—
3	TxD	RxDB(+)	RxDB(+)	DataB(+)
4	DTR	RxDA(-)	RxDA(-)	DataA(-)
5	GND	GND	GND	GND
6	DSR	—	—	—
7	RTS	—	—	—
8	CTS	—	—	—

The pin assignments for RS-485-2w serial ports are show in the following table:

Terminal Block Port

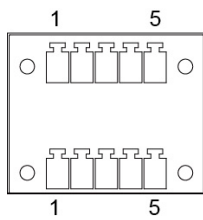

RS-485-2w Pinouts

Pin	RS-485-2W
1	–
2	–
3	DataB(+)
4	DataA(-)
5	GND

LAN Ports

The DA-685 has 6 10/100/1000 Mbps LAN ports. When the cable is properly connected, the LEDs on the front panel will glow to indicate a proper connection.

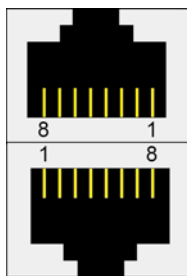
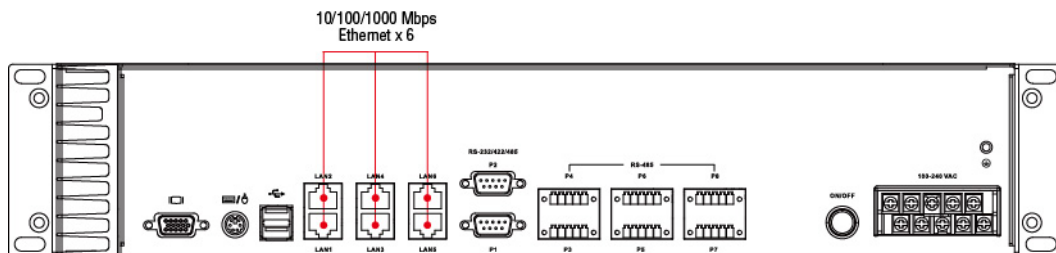

Pin No.	100 Mbps Signal	1000 Mbps Signal
1	ETx+	TRD (0) +
2	ETx-	TRD (0) -
3	ERx+	TRD (1) +
4	--	TRD (2) +
5	--	TRD (2) -
6	ERx-	TRD (1) -
7	--	TRD (3) +
8	--	TRD (3) -

LED	Color	Description
Ethernet Port 1000 Mbps	Yellow	1000 Mbps of Ethernet Port is active
	Off	No activity
Ethernet Port 100 Mbps	Green	100 Mbps of Ethernet Port is active
	Off	10 Mbps or no activity

The default IP addresses and netmasks of the Gigabit LAN ports are as follows:

	Default IP Address	Netmask
LAN 1	192.168.3.127	255.255.255.0
LAN 2	192.168.4.127	255.255.255.0
LAN 3	192.168.5.127	255.255.255.0
LAN 4	192.168.6.127	255.255.255.0
LAN 5	192.168.7.127	255.255.255.0
LAN 6	192.168.8.127	255.255.255.0

NOTE Please note that the XPE models use DHCP.

Upgrading the Memory Module

The DA-685 embedded computer supports one 200-pin DDR2 667 SODIMM module of up to 2 GB. One DDR2 SDRAM memory module is pre-installed. To upgrade the DDR2 SDRAM memory module, follow these instructions:

1. Disconnect the DA-685 from the power source.

2. The DA-685's memory module is located inside the DA-685. Use a screwdriver to remove the screws on the top cover of the DA-685.

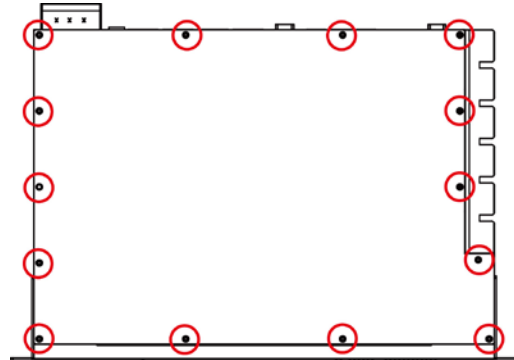

Memory Module

3. After removing the cover, you will see the DDR2 SDRAM module.

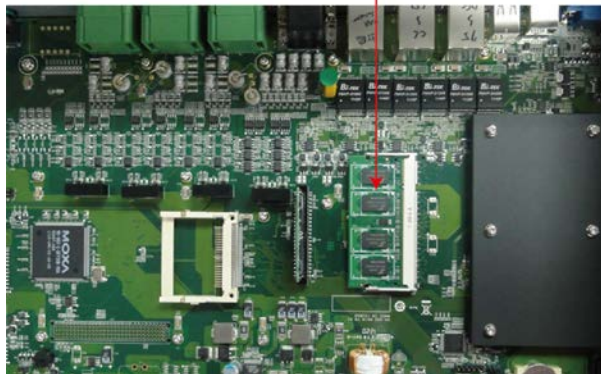

4. To upgrade the memory, you need to remove the original memory by pushing two clutches at both sides of the module.



5. Gently insert the new memory into the module. Make sure the direction is correct.



6. Push the memory all the way down to complete installation.



Installing a CompactFlash Card

The DA-685 embedded computer comes with a CompactFlash socket. To insert a CompactFlash card, follow these instructions.

1. Disconnect the DA-685 from its power source.
2. The DA-685's CompactFlash socket is located inside the DA-685. Use a screwdriver to remove all the screws on the top cover of the DA-685.

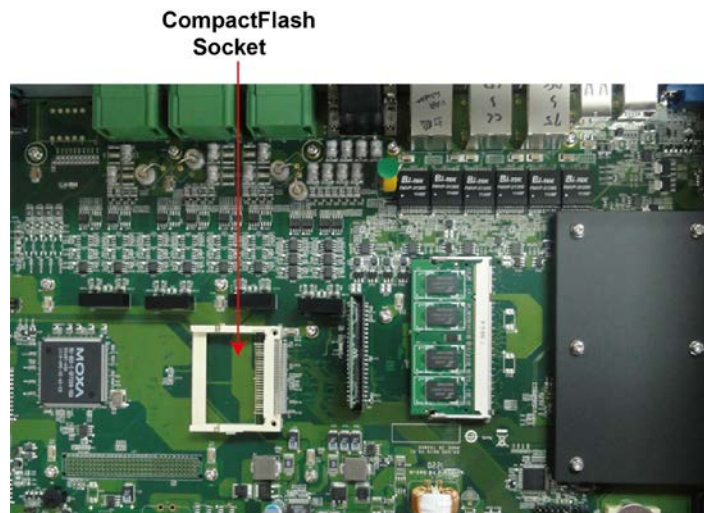

3. Insert the CompactFlash card into the socket. Push downwards to make sure that the card is firmly inserted.

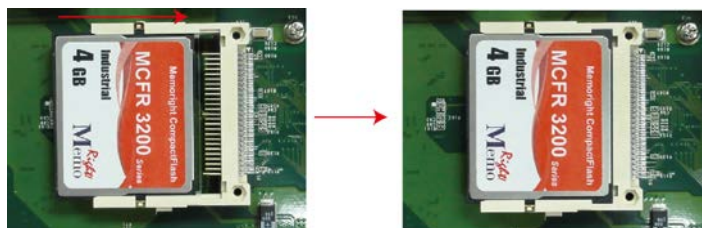

ATTENTION

Make sure you insert the card in the right direction – **do not force the card**. The card cannot be inserted if you insert the card incorrectly.



ATTENTION

The DA-685 embedded computer **does not support CompactFlash hot swap and PnP** (Plug and Play). It is first necessary to **remove the power source** before inserting or removing the CompactFlash card.

Installing a SATA Storage Drive

The DA-685 embedded computer features a single SATA connector for SATA storage drives. To install a 2.5-inch SATA storage drive (SSD or HDD) a DA-685 storage drive mounting assembly must be acquired (it is not included in the basic DA-695 packaging). To install a storage drive, follow these instructions:

1. Disconnect the DA-685 from its power source

2. Open the top cover of the DA-685; the following figure shows the specific location where the storage drive will be mounted:

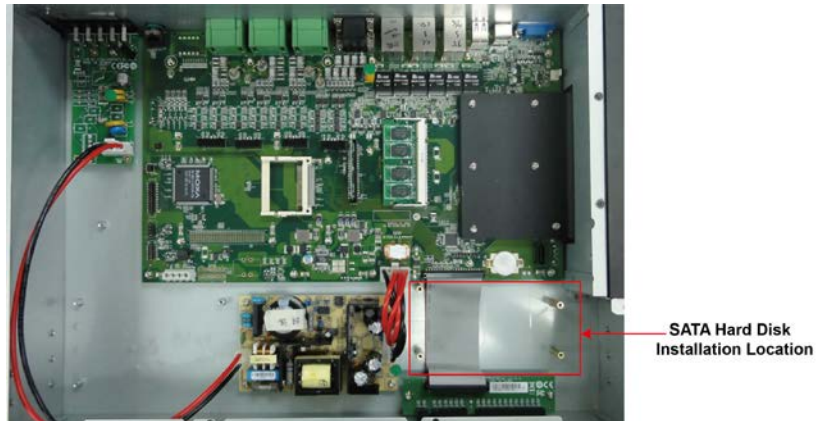

3. Retrieve the mounting bracket from the storage drive mounting kit and affix it to the drive via the bracket's side panels, using two screws:



4. Connect the power cable and the SATA cable to the storage drive:

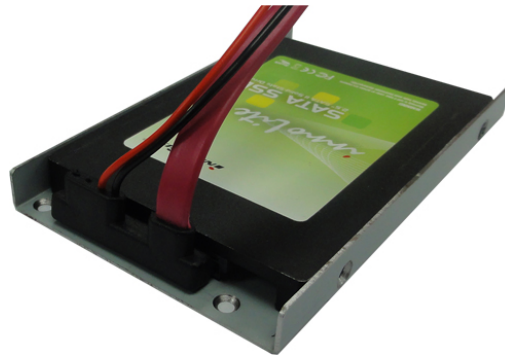

5. Place the drive bracket into the mounting space; fasten the bracket to the case using four screws, one on each corner



6. Connect the power cable and SATA cable to the motherboard, as follows:



ATTENTION

The SATA storage drive mounting assembly – which includes the SATA data and power cables – does not ship with the basic models of the DA-685 embedded computer. For purchasing information, please contact Moxa.

Upgrading a DOM

The DA-685 comes with an IDE-based DOM in which the operating system has been installed. To upgrade this DOM, follow these steps.

1. Disconnect the DA-685 from its power source.

2. Open the top cover of the DA-685. Refer to the following figure for the specific location for the DOM installation.

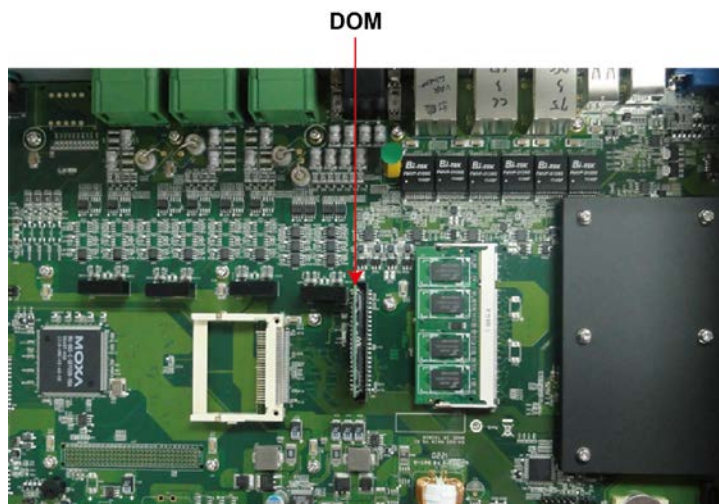

3. Remove and pull up the DOM carefully.

4. Insert the new DOM and push downwards to finish.

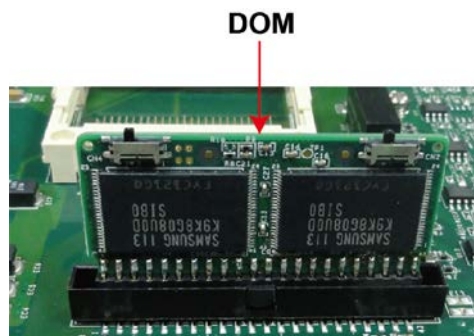

This chapter describes the BIOS settings of the DA-685 computer. The BIOS is a set of input/output control routines for peripherals. The BIOS is used to initialize basic peripherals and loads the operating system. The BIOS setup allows the user to modify the system configurations of these basic input/output peripherals. All of the configurations will be stored in the NVRAM (flash memory), which retains the system information after system reboots or the power is removed.

The following topics are covered in this chapter:

- ❑ **Entering the BIOS Setup Utility**
- ❑ **BIOS Main Page**
- ❑ **Modifying BIOS Settings**
 - Advanced Settings
 - Security Settings
 - Power Settings
 - Boot Settings
 - Exit Settings
- ❑ **Upgrading the BIOS**

Entering the BIOS Setup Utility

To enter the BIOS setup utility, press the "F2" key while the system is booting up. The main BIOS Setup screen will appear.

A basic description of each function key is listed at the bottom of the screen. Refer to these descriptions to learn how to use them.

F1: General Help	↑ ↓: Select Item
F5/F6: Change Values	← →: Select Menu
F9: Setup Defaults	ESC: Exit
F10: Save and Exit	ENTER: Select or go to Submenu

BIOS Main Page

The main page of the BIOS displays basic low-level information about system hardware, including things like model names, CPU type, and BIOS version.

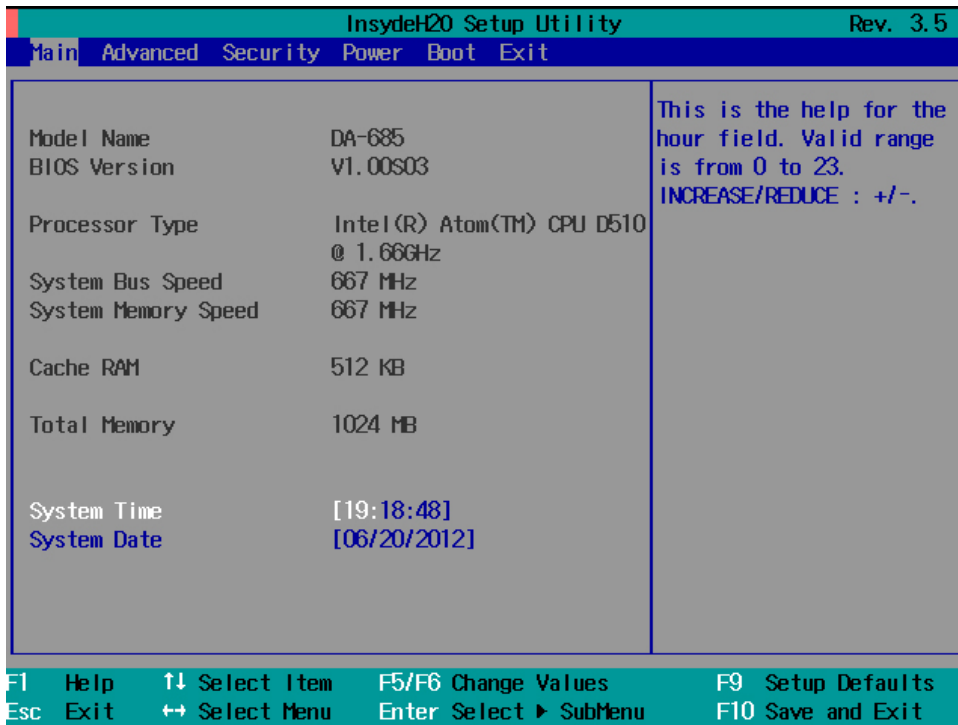

Modifying BIOS Settings

Navigate the BIOS menus using the arrow keys; up (↑) and down (↓) arrows navigate the menu, while left (←) and right (→) arrows will open or close sub-menus from entries marked with a triangle (▶) at the beginning of the line.

Advanced Settings

The “Advanced Features” screen will appear when choosing the “Advanced” item from the main menu.

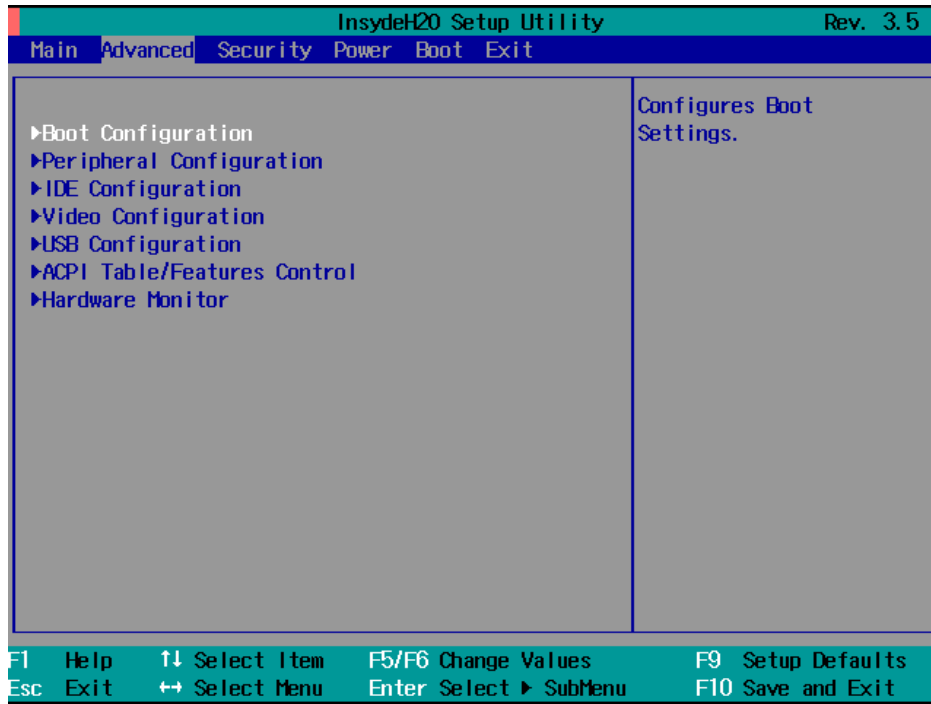

Boot Configuration

This item allows users to toggle the number pad into “on” or “off” when first booting up.

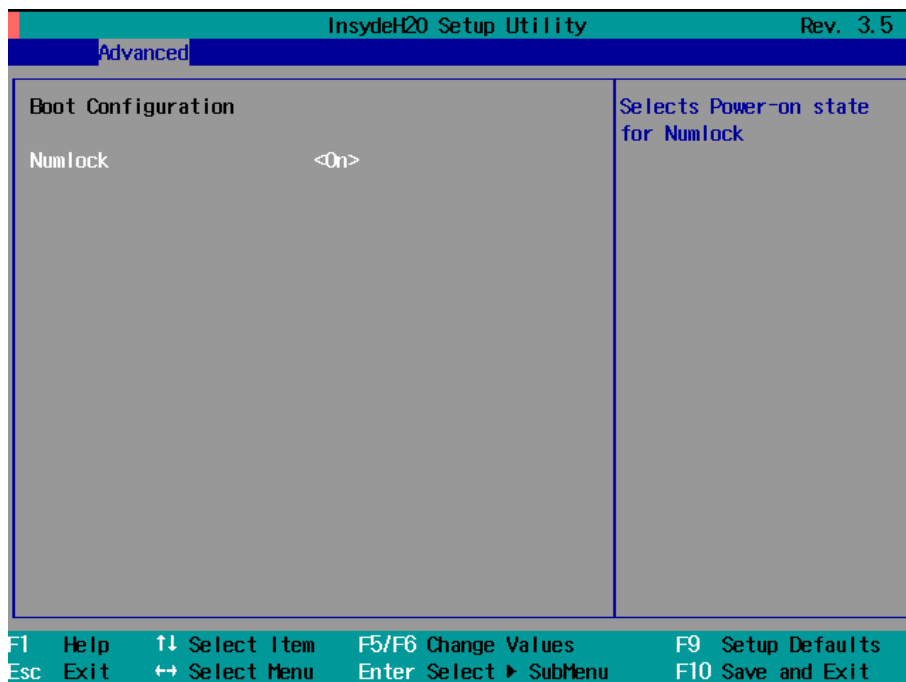

Peripheral Configuration

The **Debug Port** item under **Peripheral Configuration** allows you to select an alternate debugging interrupt. Please note that this should be used only by programmers who are familiar with debugging.

Options: 2E8/IRQ6, Disabled (default)

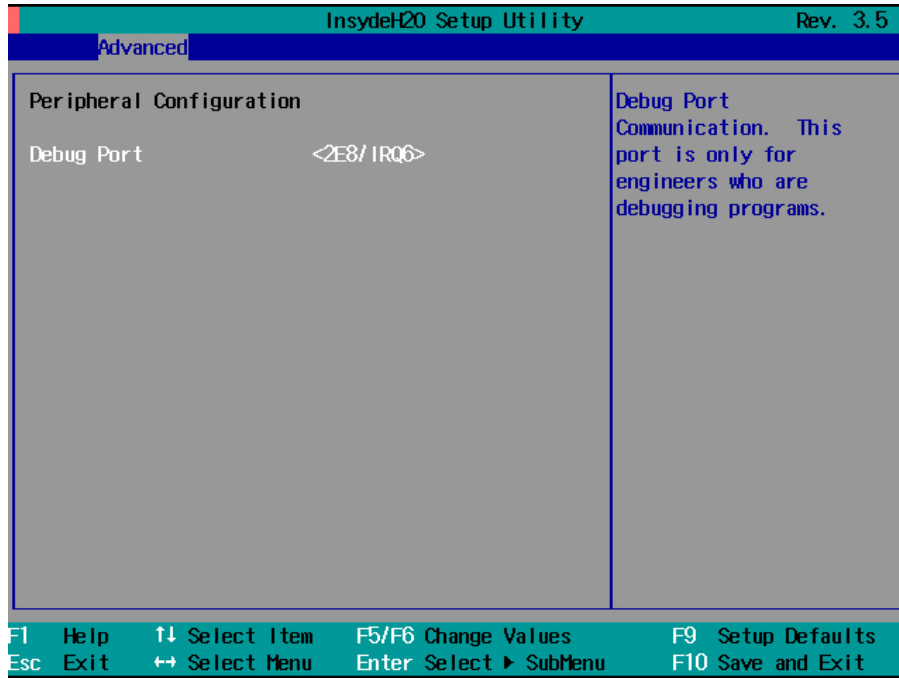

IDE Configuration

This item allows you to configure the storage drive controllers.

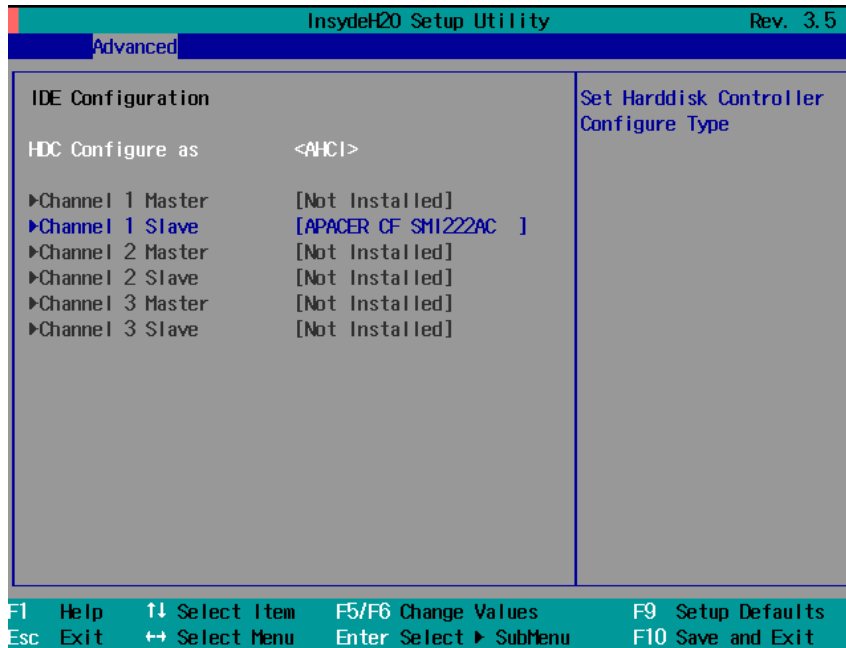

HDC Configure As

This item allows you to configure the storage drive type. The options are:

AHCI (default); **PATA**; **SATA**; and **IDE Non-Combined**

Channel Master 1 to 3

This setting displays the storage devices installed on the computer’s master bus. These storage devices may be DOMs, HDDs, SSDs, or a CF card.

Channel Slave 1 to 3

This setting displays storage devices installed on the computer’s slave bus. These storage drives may be DOMs, HDDs, SSDs, or a CF card.

Video Configuration

This item allows you to configure the video settings.

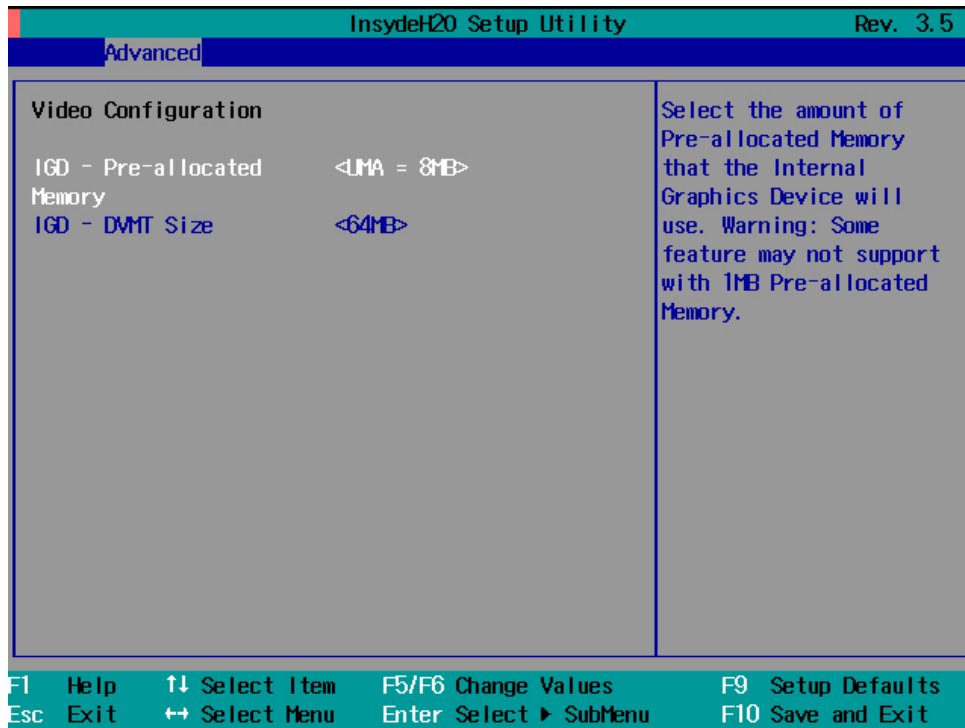

IGD – Pre-Allocated

This item allows you to configure the pre-allocated capacity for the graphic memory capacity.

Options: 8 MB (default), 1 MB

IGD – DVMT Size

This item allows you to configure the capacity of the DVMT 5.0 used by the internal graphics device.

Options: 64 MB (default) , 128 MB, 224 MB

USB Configuration

This item allows you to turn **USB Legacy** mode on or off. **USB Legacy** allows older USB devices to be accessed from the earliest boot initialization, and/or DOS.

Options: Enabled (default), Disabled

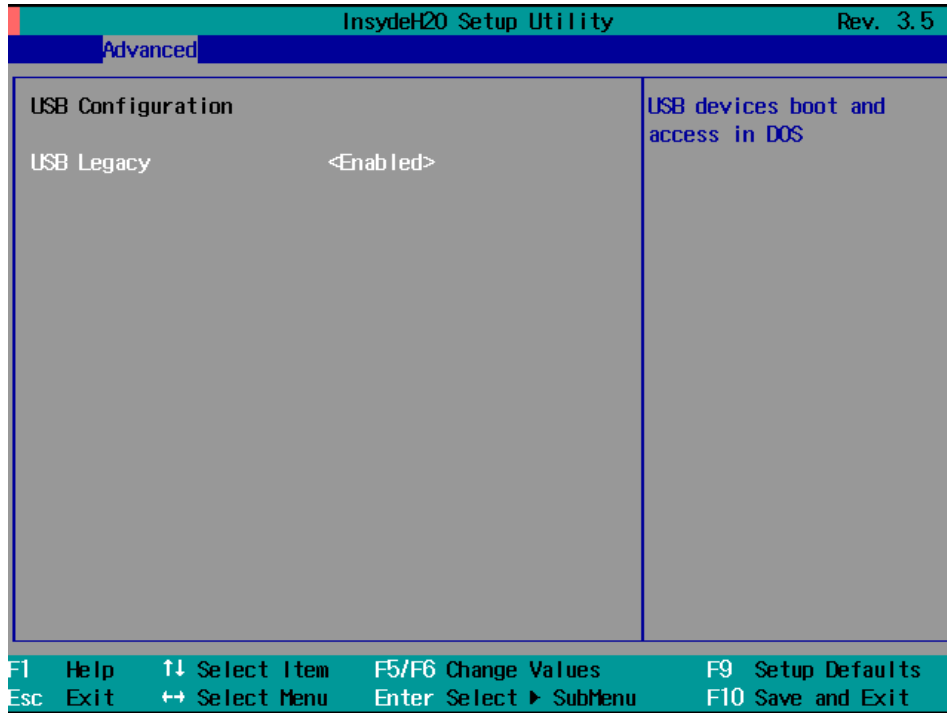

ACPI Table/Features Control

This item allows you to configure FACP and HPET functions.

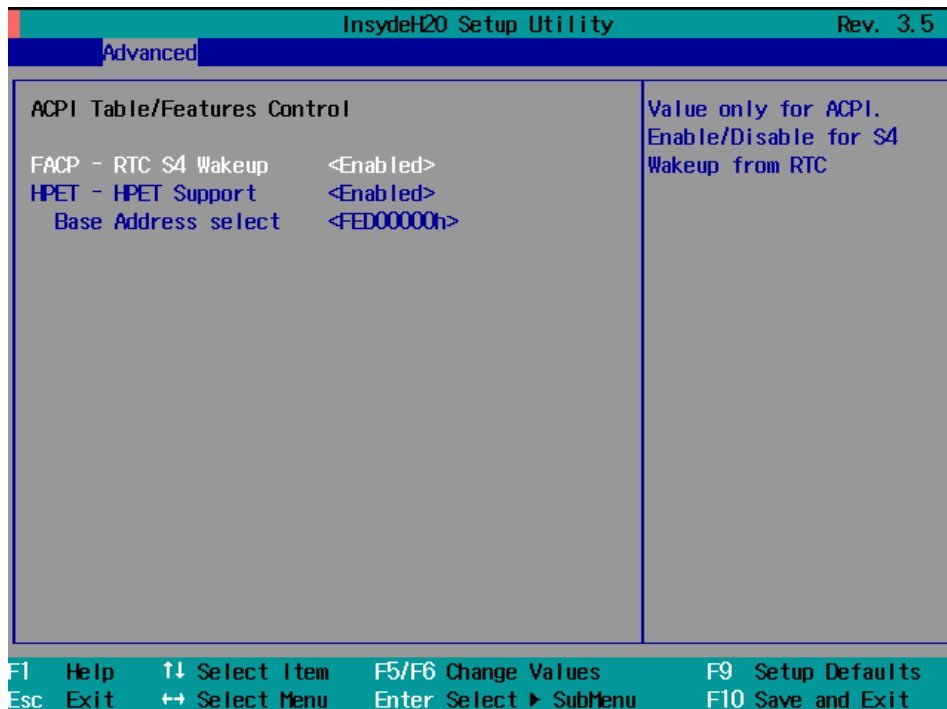

FACP – RTC S4 Wakeup

This item allows you to enable RTC wakeup, so the computer may pull itself out of sleep or hibernation mode to perform specified tasks at a certain time each day.

Options: Enabled (default), Disabled

HPET – HPET Support

This item allows you to enable/disable the HPET (High Precision Event Timer), which produces periodic interrupts at a much higher resolution than the RTC and may be used to synchronize multimedia streams. HPET can sometimes introduce system instability, so some users may wish to disable it.

Option: Enabled (default), Disabled

Base Address Select

This allows you to select the memory address range for the HPET.

Options: FED0000h (default), FED01000h, FED02000h, FED03000h

Hardware Monitor

This item allows you to view various self-reported hardware states that include CPU temperature, system temperature, and CPU voltage.

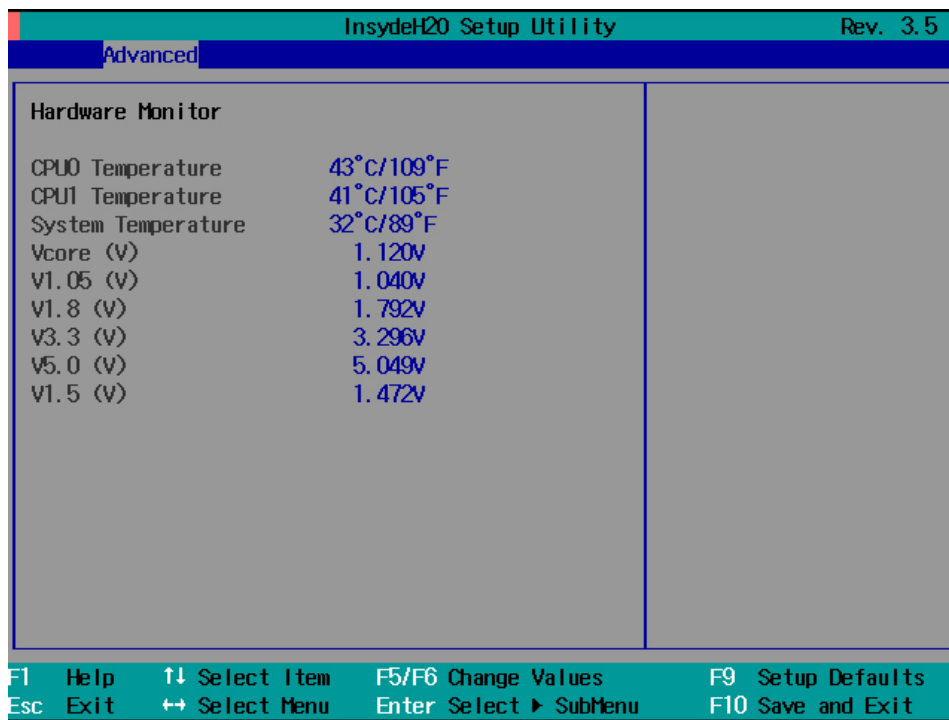

Security Settings

The section allows users to configure security settings like a system supervisor password and user password.

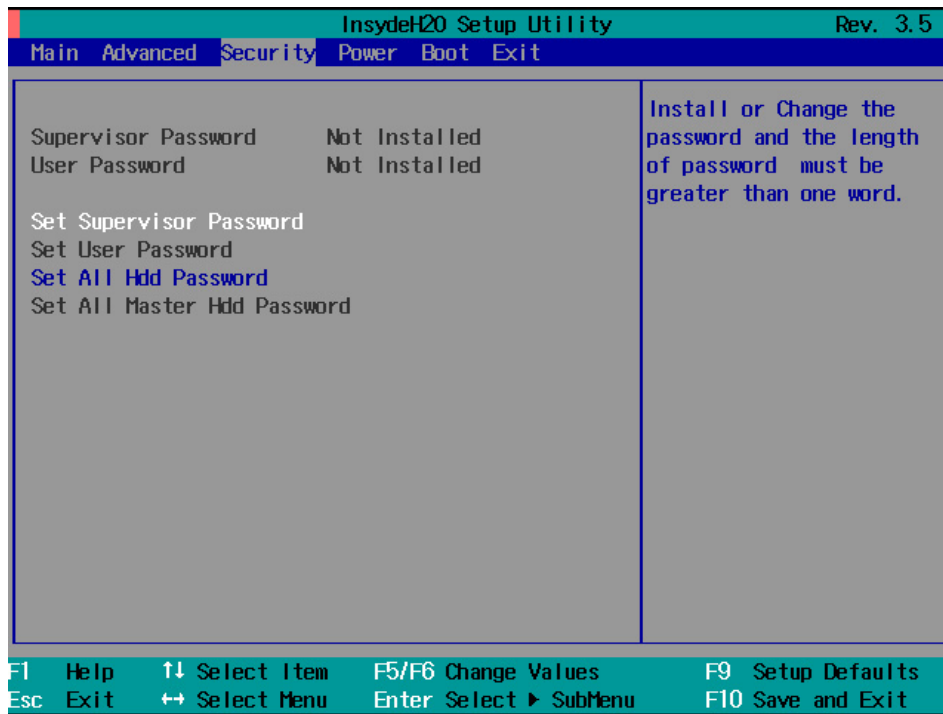

Set Supervisor Password

This item allows you to set the supervisor password. Select and then enter the password, and then confirm the password again.

Set User Password

This item allows you to set the user password. Select and then enter the password, and then confirm the password again.

Set All HDD Password

This item allows you to set the password for all storage devices on your computers, including CF, DOM and hard disk. You need to enter the password when booting up to use these storage devices.

Set All Master HDD Password

This item allows you to set the password for the master storage drive on your computer. You need to enter the password when booting up to use the master hard disk.

Power Settings

The section allows users to configure power settings.

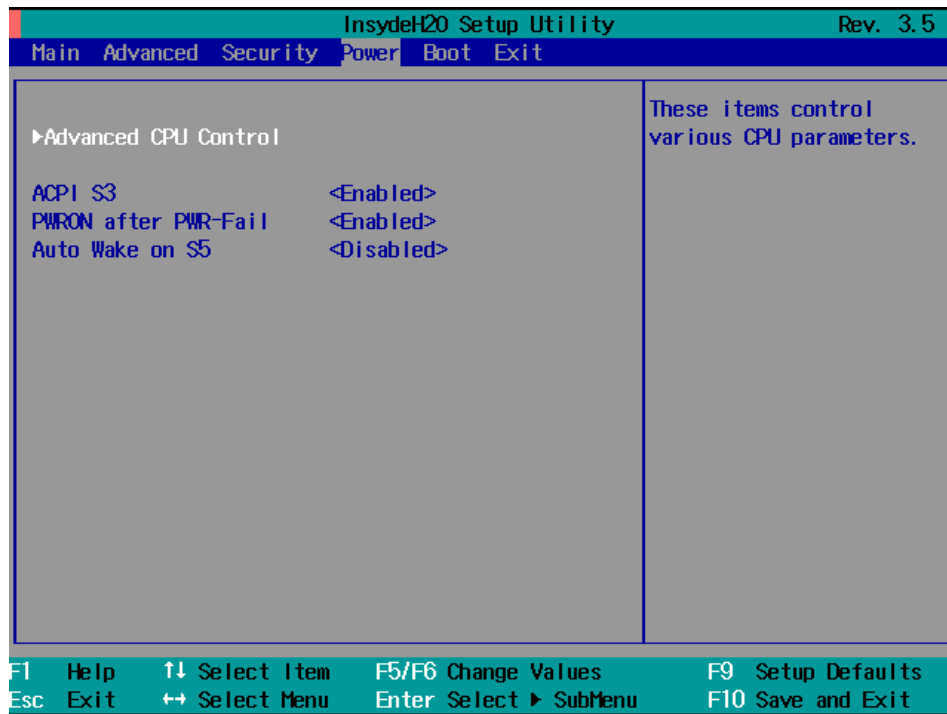

Advanced CPU Control

Thermal Mode

This item enables Intel's thermal throttling 1 technology in the CPU; it functions as a temperature trip that will throttle the CPU (and thereby decrease performance) when a certain temperature is reached. Enabling this function allows you to configure the thermal control circuit in the operating system userspace.

Options: TM1 (default), Disabled

HT Support: Hyper-Threading Technology

This item enables Hyper-Threading (HT) technology, so that the CPU may utilize simultaneous multithreading. This improves performance for multi-threaded code and gives improved reaction and response time. However, in some instances users may want to disable it to conserve power or reduce CPU cache paging.

Options: Enable (default), Disabled

Use XD Capability

This item allows you to enable/disable the Intel XD function, which provides executable space protection by toggling the NX bit in memory spaces designated as data. This gives a strong protection against buffer overflows by preventing the execution of malicious code that has been delivered into memory space in a hidden data packet. It is strongly advised to enable XD technology.

Options: Disabled (default), Enable

ACPI S3

This item allows you to enable/disable Processor Performance States (P-States) function; this technology is primarily intended for power conservation on laptops. By default, it is enabled.

Options: Disabled, Enabled (default).

PWRON After PWR-Fail (Power on after Power Fail)

This item allows you to configure the computer to turn itself back on after a power failure. If a power failure occurs and **Enabled** is chosen, the computer will automatically power up, regardless if it was on or not when the failure occurred. If **Last State** is chosen, the computer will power up if it had been on, or will remain off if it was not on when the failure occurred.

Options: Disabled, Enabled (Default), Last State.

Auto Wake on S5

This item allows you to configure the computer to wake from **S5** status. **S5** stands for **Soft Off**, where the PSU remains engaged but power to all other parts of the system is cut. Auto-wake on S5 schedules a soft-reboot at certain periodic times that may be specified in the BIOS.

Options: Disabled (default); **By Every Day** (user specifies a regular daily time when the computer will power up); **By Day of Month** (user specifies a regular day each month when the computer will power up)

Boot Settings

The section allows users to configure boot settings.

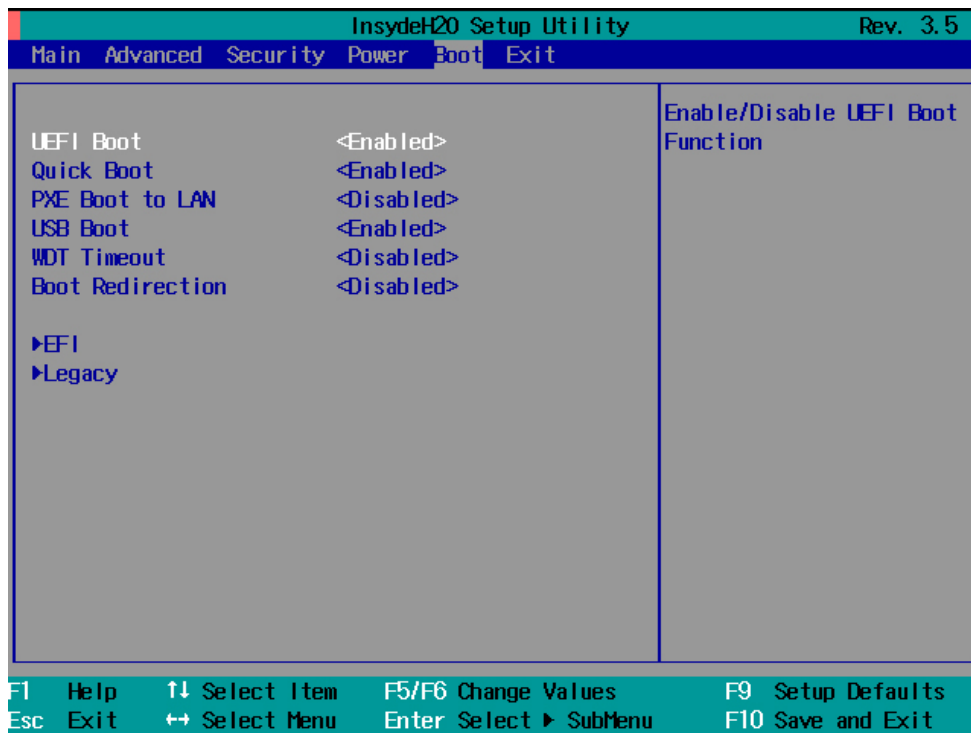

UEFI Boot

This item allows you to enable/disable the **Unified Extensible Firmware Interface**, which allows for remote diagnostics and repair of computers even without an operating system. Users who are concerned about safety or ownership issues may disable it.

Options: Enabled (default), Disabled

Quick Boot

This item allows you to enable/disable quick boot function to reduce OS loading times.

Options: Enabled (default), Disabled

PXE Boot to LAN

This item allows you to configure the **Preboot eXecution Environment's** boot-to-LAN function. **PXE** provides an independent boot environment that may be initialized over a network interface, without intermediary storage devices or local operating systems.

Options: Disabled (function), enabled

USB Boot

This item allows you to enable/disable the system to boot from a USB storage device or network connection.

Options: Enabled (default), Disabled

WDT Timeout

This item allows you to enable/disable the watchdog timer and configure its time to triggering. Watchdog timers receive messages from code that is being executed in memory, and when a hang occurs will automatically restart the system to clear the hung process from memory.

Options: Disabled (default), 1 to 10 minutes.

Boot Redirection

This item allows you to choose alternate storage and networking media to which the computer will turn following a watchdog timeout.

Options: Disabled (default), CF (CompactFlash), USB, LAN.

Please note that if you select **LAN** as the boot source then **PXE/Boot-to-LAN** must be enabled.

EFI

This item displays the boot selection for the UEFI boot function.

Legacy

Normal Boot Menu

This item allows you to configure the boot menu.

Options: Normal (default), Advanced

Boot Type Order

This item allows you to select the order in which the computer will search storage devices for bootable images; the highest device on the list will be searched first, then the second, and so on until the computer finds a bootable image. F5/F6 will allow you to change the boot order.

Options: Hard Disk Drive (default), CD/DVD-ROM Drive, USB, Others.

Hard Disk Drive

This item allows you to view information returned by the storage device (SSD, HDD) installed in the computer.

USB

This item allows you to view information about any USB device connected to the computer.

Exit Settings

The section allows users to exit the BIOS.

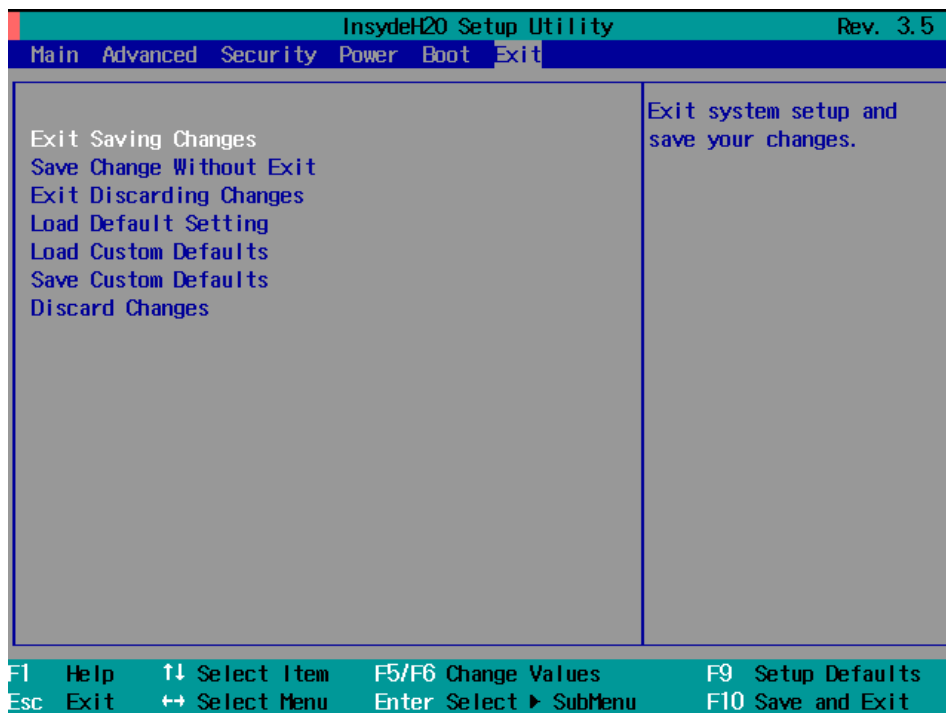

Exit Saving Changes

This item saves the values you have just configured and exits the BIOS.

Options: Yes (default), No

Save Change Without Exit

This item saves changes but does not exit the BIOS.

Options: Yes (default), No

Exit Discarding Changes

This item allows you to exit the BIOS without saving any new settings from the user session.

Options: Yes (default), No

Load Defaults Setting

This item resets the entire BIOS to factory default values.

Options: Yes (default), No

Load Custom Defaults

This item loads custom defaults across the entire BIOS.

Options: Yes (default), No

Save Custom Defaults

This item saves the current BIOS settings as the new custom defaults.

Options: Yes (default), No

Discard Changes

This item allows you to discard all settings you have just configured.

Options: Yes (default), No

Upgrading the BIOS

This section describes how to upgrade the BIOS. However, please note that it is easy to permanently damage the computer when upgrading the BIOS. We strongly recommend that you contact Moxa's technical support staff for assistance in order to obtain all necessary tools and the most current advice before attempting to upgrade the BIOS on any Moxa device.

Step 1: Create a Bootable USB Disk.

Before upgrading the BIOS every user should first create a bootable USB RAM drive as a system rescue device. A useful software suite for building USB RAM drives may be found by searching for **HP USB Disk Storage Format Tool**, which may then be downloaded and used to create a bootable RAM drive.

To create a rescue system, you will also need to download the FreeDos system files **kernel.sys** and **command.com** from <http://www.freedos.org/kernel/>.

Copy the DOS files **kernel.sys** and **command.com** to a specified directory (**C:\FreeDOS** in this example).

Start the HP USB Disk Storage Format Tool and in the drop-down menu labeled **Device** select the USB device that you want to use as a bootable disk.

Configure it to use a **FAT** file system from the **File System** drop-down.

Enter a drive name in the **Volume Label** field.

Check the option **Create a DOS Startup Disk** under **Format Options**.

Specify the directory where the system files are located (for example, **C:\FreeDOS**).

Click **Start** to format and create the bootable USB drive.

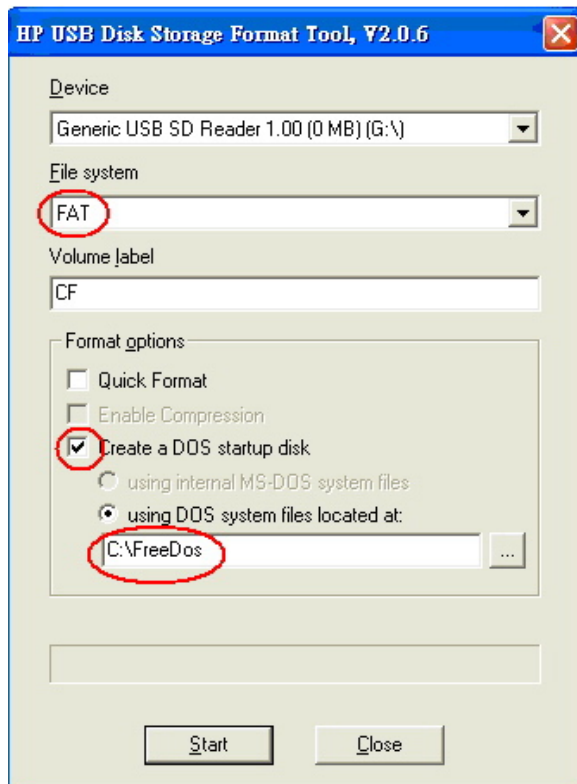

ATTENTION

We suggest you use a USB drive with under 2 GB in disk space, as larger USB drives may not support the FAT file format and will consequently fail to boot.

Step 2: Prepare the Upgrade File.

You must use the BIOS upgrade installation file to upgrade the BIOS. You can send your request to Moxa's technical support team at support@moxa.com to get an updated version of the BIOS.

1. Get the BIOS upgrade installation file. The file name should have following format: **685xxSxx.exe (xx refers to version numbers)**
2. Copy the file to the Bootable USB Disk.

Step 3: Run the upgrade program on the DA-685 computer

1. Reboot the computer and go to the Boot Manager by pressing F12 while booting up, before the operating system has begun to load.
2. Select USB Disk as the first boot source. Press Enter to continue.

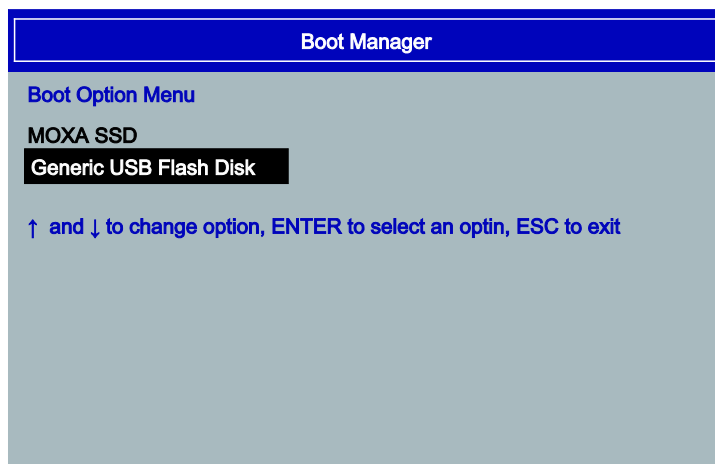

3. Once the computer boots, a DOS screen will appear. Go to the directory where the upgrade file is located. For example, if the upgrade file is stored in the DA685 folder, type:

```
#:/cd DA685
```

```
C:\ cd DA685
```

4. Run the upgrade program by typing **68510S05.exe**.

Please note that the upgrade filename may vary depending on the firmware version.

```
C:\ DA685>68510S05.exe
```

5. The upgrade program will run. Wait until the procedure is finished before initiating any changes to the system. Be patient; the upgrade will take quite a few minutes.

DO NOT ALLOW THE COMPUTER TO POWER DOWN! DO NOT REMOVE THE USB DRIVE!

```

Please do not remove the AC power!

Insyde Flash Utility for InsydeH20
                          Version 1.4b

      Initializing

Current BIOS Model name: DA-685
New   BIOS Model name: DA-685

Current BIOS version: V1.00S04
New   BIOS version: V1.00S05

Updating Block at FF845000

```

6. Once the upgrade is finished, the computer will automatically reboot. To check and see if the upgrade was successful, navigate to the **BIOS Main Page** and note the **BIOS Version number**.

```

InsydeH20 Setup Utility
Main Advanced Security Power Boot Exit

Model Name      DA-685
BIOS Version    V1.00S05
Processor Type  Intel(R) Atom(TM) CPU D510
                @ 1.66GHz

```



ATTENTION

Do NOT switch off the power supply during the BIOS upgrade. Doing so will likely cause permanent damage to your system!

Safety Installation Instructions

A. RTC Battery Warning

CAUTION: There is a risk of explosion if battery is replaced by an incorrect type. Dispose of used batteries according to the instructions.

B. Fuse Warning

CAUTION: For continued protection against fire, replace only with same type and rating of fuse.

C. Rackmount Warning

The following or similar rackmount instructions are included with the installation instructions:

(1) Elevated Operating Ambient: If installed in a closed or multi-unit rack assembly, the operating ambient temperature of the rack environment may be greater than the room ambient temperature. Therefore, consideration should be given to installing the equipment in an environment compatible with the maximum ambient temperature (T_{ma}) specified by the manufacturer.

(2) Reduced Air Flow: Installation of the equipment in a rack should be such that the air flow required for safe operation is not obstructed.

(3) Mechanical Loading: Mounting of the equipment in the rack should not create hazards that result from uneven mechanical loading.

(4) Circuit Overloading: Consideration should be given to the connection of the equipment to the power supply and the effect that overloading of the circuits might have on overcurrent protections or supply wiring. Appropriate consideration of equipment nameplate ratings must be noted when evaluating this concern.

(5) Reliable Grounding: Reliable grounding of rack-mounted equipment should be maintained. Particular attention must be given to indirect power connections that do not directly link to the branch circuit (e.g., over power strips).

D. High Temperature Warning

(1) This equipment is intended to be used in a **Restricted Access** location like a locked computer room. Access to this equipment should only be granted to **AUTHORIZED SERVICE PERSONNEL** or to users who have been instructed about the the potential heat hazard posed by the metal chassis. This computer can become so hot that after a long period of operations users and service personnel must take special care to wear protective clothing before touching it. Only **AUTHORIZED PROFESSIONALS** should be allowed direct access to an operating device.

(2) External metal parts can get dangerously hot!! Before touching it, give special attention to device temperature! Protective wear will likely be necessary!



Regulatory Statement Approval



This device complies with part 15 of the FCC Rules. Operation is subject to the following two conditions: (1) This device may not cause harmful interference, and (2) this device must accept any interference received, including interference that may cause undesired operation.

Class A: FCC Warning! This equipment has been tested and found to comply with the limits for a Class A digital device, pursuant to part 15 of the FCC Rules. These limits are designed to provide reasonable protection against harmful interference when the equipment is operated in a commercial environment. This equipment generates, uses, and can radiate radio frequency energy and, if not installed and used in accordance with the instruction manual, may cause harmful interference to radio communications. Operation of this equipment in a residential area is likely to cause harmful interference in which case the user will be required to correct the interference at his own expense.



European Community

Warning:

This is a Class A product. In a domestic environment this product may cause radio interference in which case the user may be required to take adequate measures.